

**PILATUS
PC 9-PC 9/A
ALSO
TUCANO
EMB S312
SEMISCALE SPORT MODEL**

THESE INSTRUCTIONS
ALSO APPLY TO THE
TEXAN II 45-60 ARF
AND THE
HARVARD II 45-60 ARF.

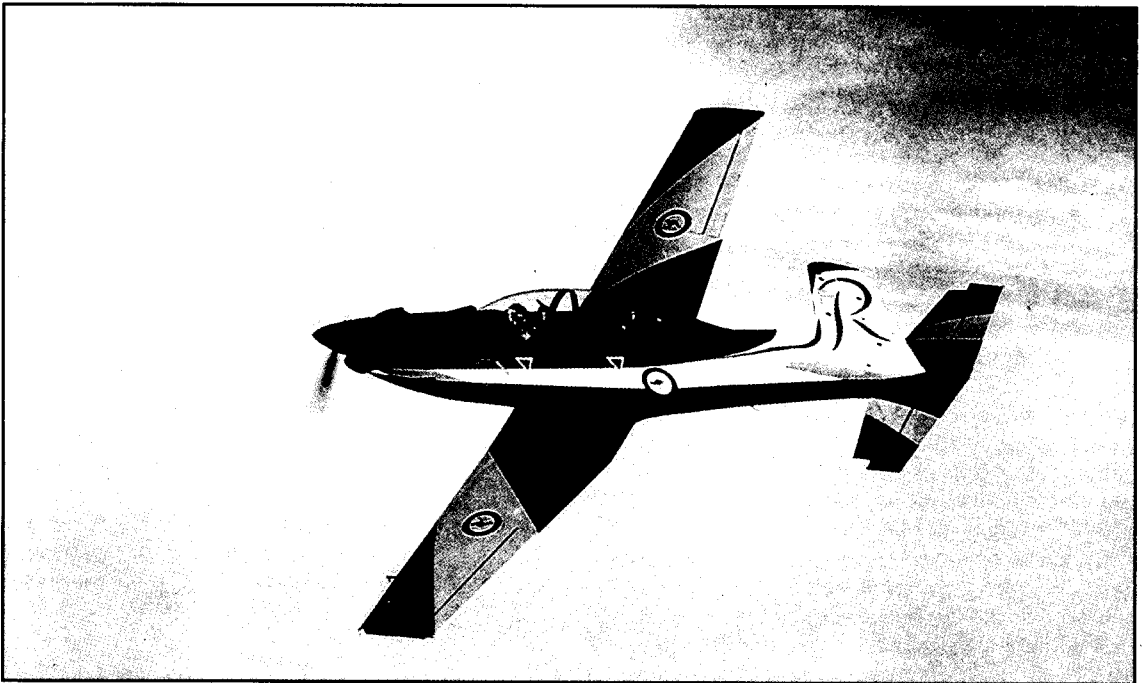

Assembly
and
Operations Manual
Please review this manual thoroughly
Before assembling or Operating
The
VMAR PILATUS PC 9 -PC 9/A
Also
TUCANO EMB S312
Semi scale sport model

Liability Disclaimer

It is important that the following liability disclaimer be **READ BEFORE ASSEMBLING OR USING THIS PRODUCT.**

Model airplanes, model engines, model engine fuel, propellers and products such as the VMAR PILATUS PC 9/A(ALSO TUCANO EMB S312) semi scale sport model can be hazardous if improperly used. Be cautious and follow all safety recommendations when using your model. Keep hands, tools, clothing and all foreign objects well clear of engines when they are operating. Take particular care to safeguard and protect your eyes and fingers and the eyes and fingers of other person who may be nearby. Use only a good quality propeller that has no cracks or flaws. Stay clear of the propeller and stay clear of the plane rotation defined by the propeller.

The Manufacturer, Distributor, Retailer and/or other suppliers of this product expressly disclaim any warranties or representations, either expressed or implied, including but not limited to implied warranties of fitness for the purposes of achieving and sustaining remotely controlled flight.

In no event will the Manufacturer, Distributor, Retailer and/or other suppliers of this product have any obligation arising from contract or tort, or for loss of revenue or profit, or for indirect, special, incidental, consequential or other damages arising from the use of this product.

In purchasing and/or using this product, the user accepts all responsibility for its use and accepts all liability associated with such use.

Proceeding with assembly and use of this product Indicates Agreement With and Acceptance of the Liability Disclaimer .

CAUTION.

A Remote Control Model Aircraft is not a toy. It is a flying model that functions much like a full size airplane. If you do not assemble and operate this product improperly you can cause injury to yourself and others and damage property. DO NOT FLY this model if you are not qualified.

You are ultimately responsible for the mechanical, aeronautical and electrical integrity of this model and it's structure, control surfaces, hinges, linkages, covering, engine, radio, wiring, battery and other components before and after each flight. Do not fly until it's right!

INTRODUCTION

Thank you for purchasing a VMAR product. VMAR Manufacturing is committed to delivering superior value to the RC modeler. Your new VMAR Mentor is the market leader in features, ease of use and flexibility. Please review these instructions before beginning the simple assembly procedure.

We've used metric measurements thorough out these instructions. We know that some of you like metric while others think that furlongs per fortnight makes a nifty velocity indicator. If you are in the furlong camp, bear with us. It's not a big deal. 3 millimeters is stated as 3mm and 3mm is about 1/8 of an inch. Fire up your confuses and you will find that 25,4mm makes an inch. In places where you have to actually set up something according to a recommended measurement, we've listed an approximate imperial measurement in inches in brackets.

Whenever we've used the directional terms left or right, they are with respect to the Mentor when viewed as you would from sitting in the cockpit that is when viewed from the back looking forward.

You will likely be looking for quality clevises on your control surfaces. Most ARF's use factory grade clevises that leave you somewhat wanting in the confidence department. Guess what? The Mentor uses metal pin clevises on all control surfaces! You won't be throwing our clevises in file 13 you'll be flying them with confidence in your model.

We've coupled those tough metal pin clevises to super strong steel push rods that run in plastic tube guides all the way from the tail to the radio compartment! Connections between the threaded control rods and the servo arms are done also with custom VMAR metal pin clevises that have been designed to accommodate the high angular rotation of the servo arms. Nothing but nothing is going to break, bend, fail or otherwise cause you grief between your servo's and the tail feathers of your model. Did we say servo tray? You bet! Not only do we provide a servo tray but it is the best most universally adjustable tray available any where. Once you see how our servo tray works, you'll be trying to buy them as a part!

Another feature that experienced RC flyer look for is "pinned" hinges that do not rely solely on the hinge glue to keep the control surfaces attached. Look no further. Turn over a model wing and look at the outboard and inboard hinges yup, they're pinned! Double pinned in fact! Better yet we've done all the end hinges on the rudder and elevator as well!!!

Don't have a drill and tap system for installing your engine? Relax, we've already done it for you by providing

a cast aluminum engine mount (check how much these cost in the store and you'll wonder how we can do it.) that has been pretapped and comes with black allen head machine screws and engine clamp straps. Put your engine on the mount, line it up, cinch down the clamps and you are done with the mounting stuff!

INDEX.

Liability Disclaimer and Caution	Page 2
Introduction	Page 2
Check Out the Contents	Page 3 - 4
Wing Assembly	Page 4 - 6
Wing Servo Installation	Page 6 - 7
Installing the Landing Gear	Page 7 - 9
Installing the Fuel Tank	Page 9 - 10
Installing the Engine	Page 10 - 12
Installing the Stabilizers	Page 12 - 14
Installing the Radio	Page 14 - 17
Balancing	Page 17
Functional Integrity	Page 17 -18
Caution	

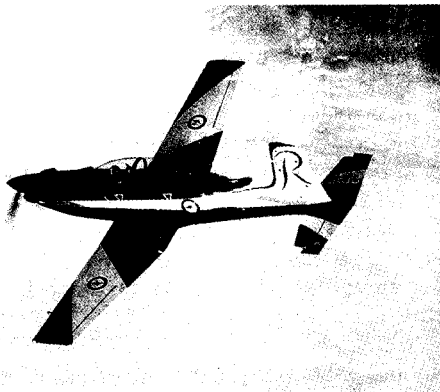

PHASE 1 - CHECK OUT THE CONTENTS.

You've taken the lid off the box and grabbed the instruction booklet—you are about 6-8 hours away being ready to go flying! Now is the time to look over what's in the box. Please go through the contents and make sure nothing has been damaged in shipping. **Damage or**

missing components must be reported to your vendor BEFORE any assembly begins. Please DO NOT START if something is damaged or missing. As you can imagine, once you join the wing halves or install your radio or engine your options for returns are very limited. Your vendor will not be able to provide you with exchanges or replacements of parts that have been assembled. DO NOT START UNLESS IT'S RIGHT!

STEP 1.1 - CHECK OFF COMPONENTS AND PARTS INCLUDED.

- 1 Right wing
- 1 Left wing
- 1 Fuselage assembly with elevator and rudder push rods, 2 pieces throttle control rod, universal servo tray, power module and fuel tank (pre-installed by factory.)
- 1 Vertical stabilizer with pre-installed rudder.
- 1 Horizontal stabilizer with pre-installed elevator .
- Fiber glass cowl.

Contents of Part Bag One

- 1 Wooden wing spar joiner.
- 3 Ultra light treaded wheels 62mm (2-7/16 in.) diameter
- 1 pre-bent metal nose gear wire
- 1 Fuel tank with stopper & pre-bent metal tubing
- 1 Spinner (nose cone) with screws.
- Part bag two and part bag three

Contents of part bag two

- 2 Aileron control rods with clevises at both ends
- 1 Small roll of wing joiner tape
- 2 Plastic wing bolts
- 2 Wooden Guide Blocks
- 8 Sheet metal screw approx. 18mm (3/4in.)long
- 4 plastic landing gear retainer.

Contents of Part Bag Three

- 6 Wheels collars with set screws. 2 used with nose wheel. 4 spare
- 1 Nose gear steering arm with set screw
- 2 Metal bolts 2.5mm x 25-30mm (1 to 1-3/16")
- 2 Plastic control horns
- 2 Plastic beveled washers
- 2 Plastic T-nuts

Contents of Parts Bag Four

- 2 Black plastic adjustable slider plates for mounting the servos.
- 7 small screws for mounting the adjustment plates and the universal servo tray
- 1 EZ connector
- 1 Allen wrench for the set screw in the EZ connector

Loose material in the box

- Red covering patch sheet.
- White covering patch sheet
- Black covering patch sheet.
- Assembly and operations instructions

STEP 1.2 CHECK OFF TOOLS AND SHOP MATERIALS NEEDED.

These tools and shop materials are not included and are required to complete and operate your PILATUS and most other remote control aircraft. For some specific recommendations and part numbers please see the attached listing tools and materials available in your market area.

- Clean and flat table or work surface approximately 600 x 1800 mm (24 x 72 in.)
- 2.5 mm ball socket screw driver or Allen wrench
- 3.0 mm ball socket screw driver or Allen wrench
- 4.0 mm ball socket screw driver or Allen wrench
- Phillips (cross head) screw driver small size
- Phillips (cross head) screw driver medium size
- Flat blade screw driver medium size
- Masking tape, ruler or tape measure
- Side (" wire") cutters
- Pencil, pliers, hobby knife with #11 blade
- 30 minute Epoxy and 240 grit sandpaper (optional if gluing wing)
- Silicon Based Sealant (Dap - A - Goo)
- Epoxy mixing dishes, brushes and sticks
- Paper towels
- Rubbing alcohol
- Crescent wrench (optional)
- Heat gun for covering (optional for covering touch up)

STEP 1.3 CHECK OFF OTHER ITEMS NEEDED TO COMPLETE THE MODEL

These items are not included and are required to complete and operate your Mentor and most other remote control aircraft.

- Medium fuel tubing approx. For your choice of engine and fuel. 500 - 750 mm (24-36 in.)
- Liquid thread locker
- RC FM radio with at least four channels of control and on a frequency appropriate for your market area.
- Four servos compatible with the RC FM Radio. Servos generally are sold with new radio systems
- External Switch Actuator appropriate for your radio system (optional)
- Engine and muffler suitable for use in a remote control model aircraft. A two stroke glow fuel .40 - .53 cubic inch engine is recommended.
- Propeller suitable for the engine. See the engine instruction manual recommendation for diameter and pitch.
- Engine glow plug
- Engine glow plug igniter
- Engine 4 way wrench
- Fuel for the engine
- "After run" oil for engine
- RC Foam sheeting for wrapping radio receiver and battery pack.

STEP 1.4 CHECK OFF OPTIONAL EQUIPMENT AND ACCESSORIES.

These items are not included and are not required but make the operation of your PILATUS and most other remote control aircraft easier & more enjoyable.

- Power Tote Deluxe field box # VMA-PT 109D
- Fuel pump and connecting tubing
- Fueling valve
- Chicken stick or electric starter
- Stick on weights
- Battery to power electric starter
- Battery charger
- Power Panel to manage starter and pump if electric.
- Extra propellers
- Extra Glow Plugs
- Mics Tools
- Engine test stand # VMA - ETS 120
- 1/4" - 20 NC Tap

PHASE 2 - WING ASSEMBLY.

STEP 2.1 - JOINING THE WING HALVES

2.1.1 To join the wing halves you will need the following items :

- Wing joiner supplied with kit.
- Two short dowel guides supplied with kit
- Rolled trim strip supplied with kit
- 30 minute epoxy
- Sandpaper (Coarse 240 grit recommended)
- Epoxy brush or stir sticks
- Disposable mixing dish for the epoxy
- Masking tape to hold the wing in position while the epoxy sets
- Pencil
- Ruler
- Paper towels.

2.1.2 Remove the wing halves from the plastic bag while they were shipped in. Sand the wing joiner and two dowel guides slightly with sand paper, to rough up the surfaces and remove any possible obstruction. Using a pencil and ruler making the center of the wing joiner and the center of the two dowels. This mark will serve as the centerline when joining the wing halves.



Wing Joiner

2.1.3 Trial fit the wing joiner and the dowel guides into one of the wing halves. Remove them and trial fit the other ends of the wing joiner and dowel into the other wing half. Now carefully trial fit the wing halves together using the wing joiner and dowels to self align the wing.

Wipe away excess epoxy with the paper towel. To avoid smearing epoxy over the wing surface, wipe along the joint, not across it.

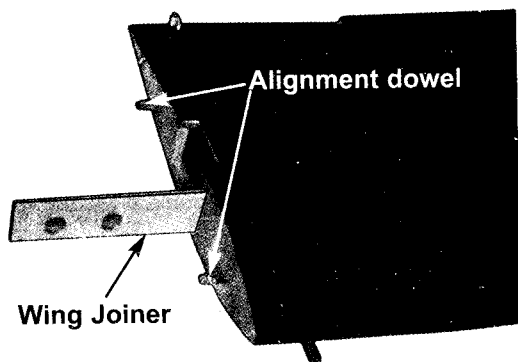

2.1.4 Pull the wing carefully apart. Mark the wing joiner with a pencil arrow indicating which way up and then remove the wing joiner and dowel guides entirely.

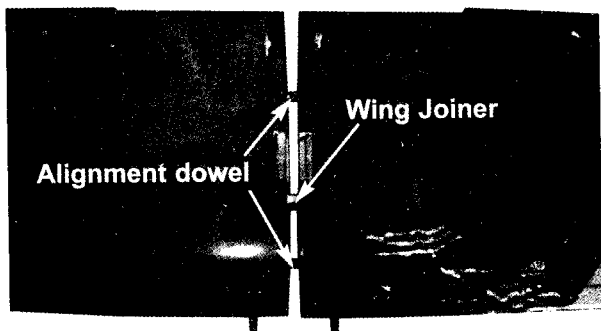

2.1.5 Mix approximately 3 ounces of 30-minute epoxy. Do not use faster curing epoxy. It does not have the strength or working time required. Do not skimp on the amount of 30-minute epoxy. It is extremely important to use plenty of epoxy when gluing the wing halves. Using a epoxy brush or stir stick, apply a liberal coating of Epoxy to both sides of one end of the wing joiner. Apply Epoxy into the wing joiner slot in the end of one wing panel and use the Epoxy coated end of the wing joiner to force epoxy down into the slot. Push the wing joiner until it reaches the pencil line. The idea is to work Epoxy thoroughly into the wing slot. Apply more Epoxy as required. Now do the same for the other wing half. Remove the wing joiner and set it aside for a few minutes.

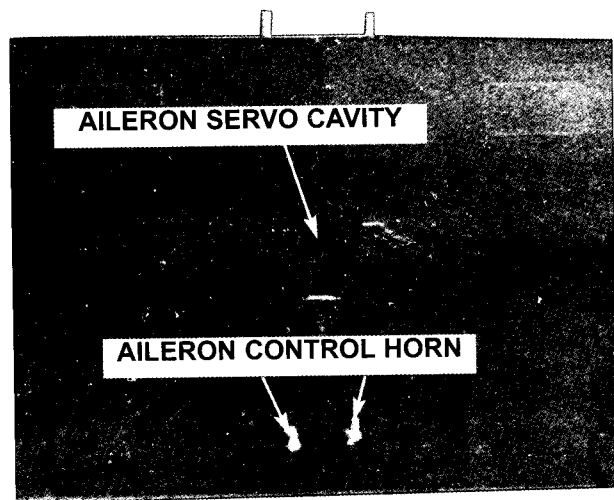

2.1.6 Apply Epoxy to the wing root joining areas on both wing halves. Apply Epoxy to the dowels and dowel holes. Insert both dowels into two holes in one of the wing halves until they are about 1/8" from the centerline you drew with the pencil. Now apply Epoxy to the other end of the dowels and liberally to the entire wing joiner. Be careful to ensure that the wing joiner is right way up, check for the arrow you drew earlier and. Insert the wing joiner into one wing half and push it in until the penciled centerline is reached.

2.1.7 Carefully slide the wing halves together. Push hard and use an extra set of hands if necessary. Push until the wing root joining areas on both wing halves are touching each other. Push hard to ensure that there is no gap between the wing halves. Wipe away any excess Epoxy with a paper towel. To avoid smearing Epoxy over the wing surface, wipe along the joint, not across it.

2.1.8 Apply masking tape over the wing joint to hold the wing halves tightly together while the Epoxy cures. Place the wing on a large flat surface and allow it to dry for at least two hours before handling. Let it cure overnight before flying.

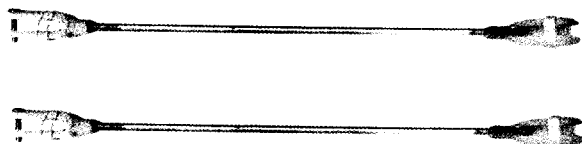

Aileron control rod

2.1.9 Peel off the masking tape and carefully apply the rolled trim sheet material supplied with the kit. Center the trim material over the joint and ensure that the ends of the trim material are on the bottom surface of the wing.

STEP 2.2 - INSTALLING THE AILERON SERVO INTO THE WING.

2.2.1 To install the aileron servo into the wing you will need the following items :

- Servo
- Servo mounting screws and grommets as supplied with servo.
- Servo control arm as supplied with the servo.
- Two 6-1/4" control rod assemblies supplied with the kit. The assemblies consist of a 5-3/4" rod with a plastic clevis screwed onto both ends.
- Masking tape.

2.2.2 Trial fit the aileron servo into the servo mounting cavity at the center of the wing. You may have to modify the cavity slightly to provide the clearance of the servo and the servo wires. Use a hobby knife to modify the cavity as required. Most servos have their output shaft closer to one end than the other . We recommend locating the servo so that the output shaft is far away from the back of the wing as possible.

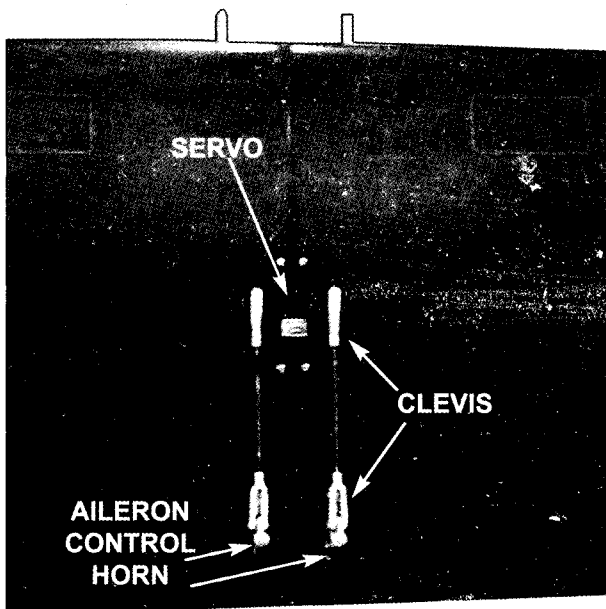

2.2.3 Screw the servo into place with the screws and grommets.

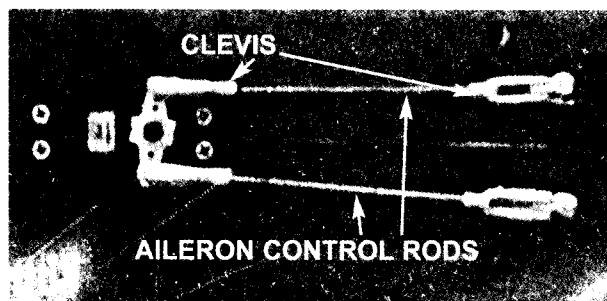

STEP 2.3 - INSTALLING THE AILERON LINKAGES.

2.3.1 Center the aileron servo by plugging it into the aileron channel in the receiver. Turn on the transmitter and then the receiver. Center the aileron trim lever on the transmitter. Remove the servo arm mounting screw and the servo arm.

2.3.2 Mount the servo arm back on the servo. Position the arm to be parallel with the back edge of the wing. Screw the arm into place with the servo arm mounting screw supplied with the servo.

2.3.3 Tape the ailerons into their neutral position so that they are even with the trailing edge of the wing and not pointing either up or down.

2.3.4 Ensure that the aileron control horns are screwed onto the threaded aileron torque rods that protrude from the wing and that both control horns are in approximately the same place on their respective torque rods.

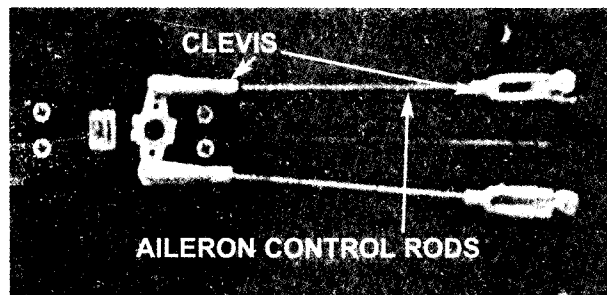

2.3.5 Connect the aileron servo rods to the aileron control horns. If one of the two clevises on each rod has a metal pin or screw. Attach that clevis to the aileron control horn.

2.3.6 Connect the other clevis to the servo output arm

2.3.7 Remove the masking tape holding the ailerons.

2.3.8 Turn on your radio and activate the ailerons, using the aileron stick and ensure a smooth full motion can be achieved.

2.3.9 With the wing top side up and view from the back, ensure that moving the transmitter aileron stick to the left

raises the left aileron and lowers the right aileron. Movement of the stick to the left will roll the aircraft to the left.

(Counterclockwise roll of the wing when viewed from the back).

2.3.10 With the wing top side up and viewed from the back, ensure that moving the transmitter aileron stick to the right raises the right aileron and lowers the left aileron. Movement of the stick to the right will roll the aircraft to the right.

(Clockwise roll of the wing when viewed from the back.)

2.3.11 If when doing the tests noted in 2.3.9 and 2.3.10 the direction of the aileron deployment is incorrect, consult your radio manual for how to reverse the direction of rotation of your servo. Control surface movement and alignment will be checked again during the final set up but it is a good idea to set things up properly as you go along with the assembly of your kit

PHASE 3 - INSTALLING THE LANDING GEAR.

Your PILATUS comes with the tricycle gear configuration using the steerable nose wheel and the main gear

STEP 3.1 - MENTOR TRICYCLE GEAR CONFIGURATION.

To install the wire main landing gear and the steerable nose wheel that comes with the PILATUS you will need the following items :

- Two pre-bent main landing gear wires supplied with the kit.

Nose gear

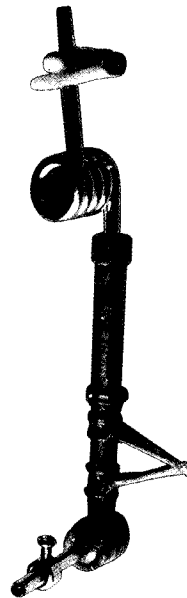

- Four plastic main landing gear straps.
- Eight mounting screws for main landing gear straps
- Three main wheels
- Six wheel collars with set screws
- The pre-bent nose gear wire
- The nose gear steering arm with set screw
- A hobby knife (optional)
- Slot head screw driver (optional)
- A long handled Allen key or ball wrench for the nose gear set screw (optional)
- Thread locker such as Pacer Z 42 or similar (optional)

STEP 3.2 - INSTALLING WHEELS.

3.2.1 Using one of the pre-bent main landing gear wires, install one of the main wheels on the wire using two wheel collars and one of the three main wheels. Install them onto the end of the end of the wire that has about 1" of wire between a gentle bend and the other end of the wire. Install one wheel collar, then the wheel and finally the second wheel collar. Tighten down the set screws on the wheel collars. Ensure that wheel can rotate freely and apply a suitable thread locker.

3.2.2 Repeat this procedure for the second pre-bent landing gear wire.

3.2.3 Install the third of the three main wheels onto the pre-bent nose gear wire using the remaining two wheel collars and a suitable thread locker.

STEP 3.3 - INSTALLING THE MAIN LANDING GEAR

3.3.1 Locate the main landing gear slots on the bottom of the right and left wing. These slots are covered

Left main landing gear

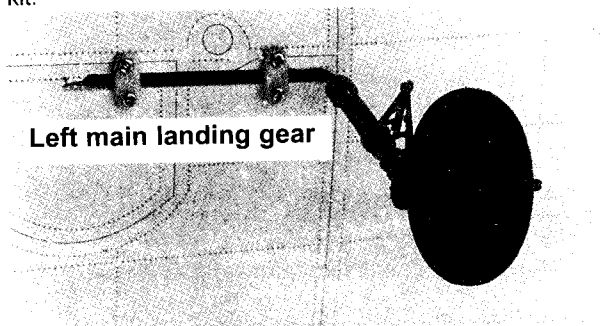

Right main landing gear

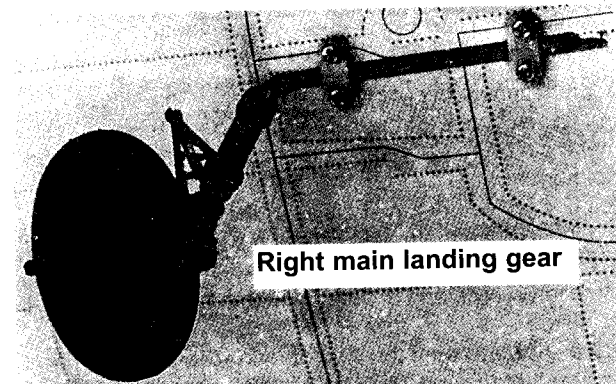

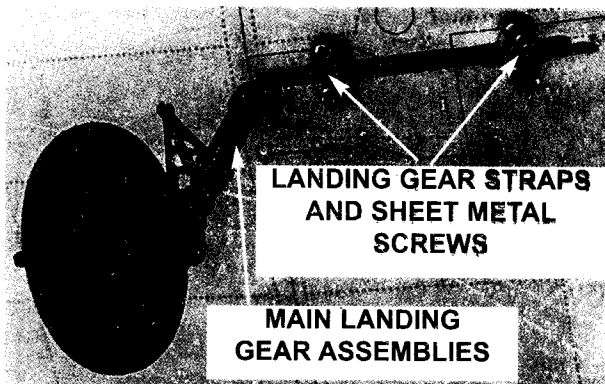

by covering material but easily seen and felt by inspecting the bottom of the wing halves. The slot for the tricycle gear configuration is approximately 143mm (4 in.) from the leading edge of the wing.

3.3.2 Using a hobby knife carefully cut away the covering and expose the main landing gear slot.

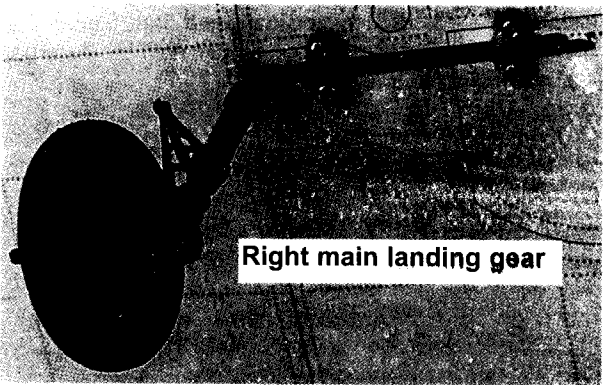
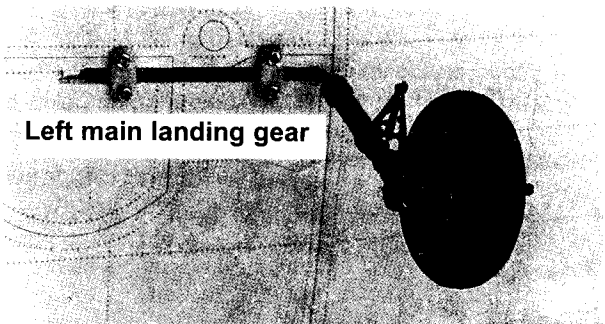

3.3.3 Locate the four pre-drilled holes for the landing gear clamp screws. They are located on the either side of the main landing gear slot (pre- drilled by factory) .

3.3.4 Install the pre-bent landing gear wire into the main landing gear slot in the bottom of the wing. Use pressure as required to force the wires down snugly into the slot.

3.3.5 Install the two main landing gear clamps and

retain them with the four screws supplied.

STEP 3.4 - INSTALLING THE STEERABLE NOSE GEAR.

3.4.1 The steerable nose gear block is located on the power module (pre-installed by factory).

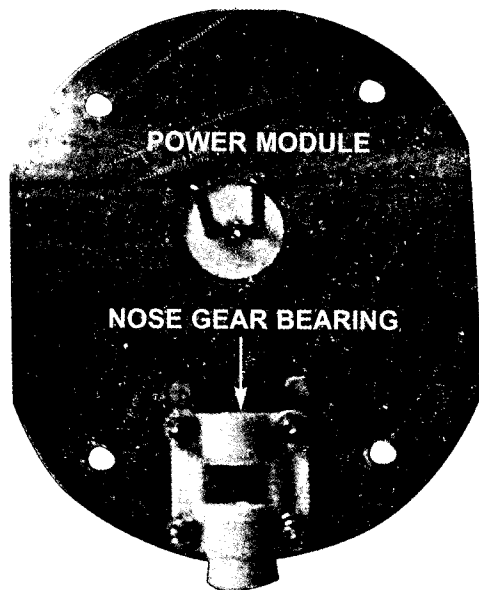

3.4.2 Install the steerable nose gear using the nose gear wire, the nose gear steering arm, the pre-installed nose gear block and the pre-installed EZ connector that will connect the nose gear steering arm to your steering servo. To do this first back off the steering arm set screw. Now put the end of the steering wire to the pre-installed EZ connector.

3.4.3 With the steering wire in place through the hole of the EZ connector in the steering arm, position the steering arm into the pre-installed nose gear block, and from the bottom of the fuselage, insert the non-wheel end of the nose gear wire up through the nose gear block and the steering arm. Rotate the nose gear assembly so that the wheel point straight ahead and the coil spring is closer to the tail of the fuselage, then push the nose gear wire into the nose gear block until the end of the gear wire contact the bottom of the motor mount. Pull the nose gear wire back out of the nose gear block slightly to leave a bit of clearance between the motor mount and the end of the wire. Rotate the steering arm so that it lies about 30 degrees rotated forward and away from the firewall.

3.4.4 Standing the fuselage on it's wheels on a flat table, adjust the vertical position of the nose gear assembly up and down in the nose gear block so that the wing saddle (this is the top edge of the fuselage where the wing will sit) is level with respect to the table top. When you've got the nose gear wire adjusted up and down so that the model is sitting level, tighten down the steering arm set

screw using the long Allen key or ball wrench inserted through the access hole under the nose. Apply a suitable thread locker to the setscrew.

The "leveling" of the fuselage using the nose gear wire and the steering arm setscrew is not particularly critical. Just loosening the steering arm set screw and adjusting the rotational and vertical position of the nose gear wire and the steering arm so that you end up with the nose wheel pointing straight ahead, the steering arm rotated about 30 degrees forward away from the firewall and the fuselage sitting approximately level.

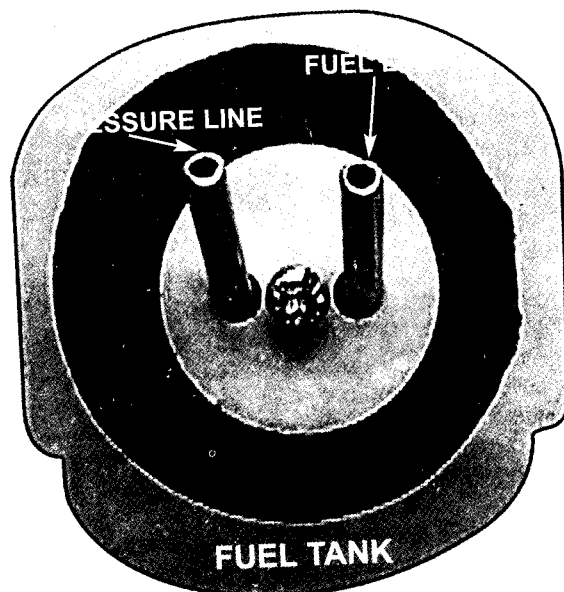
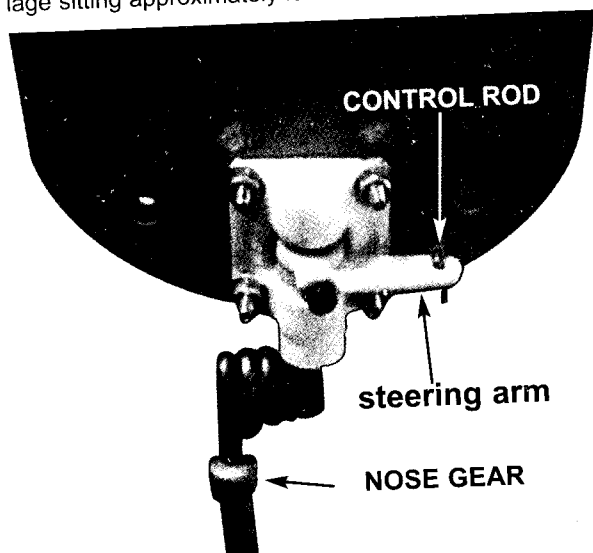

PHASE 4 - THE FUEL TANK

STEP 4.1 ASSEMBLING THE FUEL TANK.

4.1.1 To assemble the fuel tank you will need the following items :

- The fuel tank and fuel stopper assembly (supplied)
- The clunk (supplied)
- About 7" (20 cm) of medium ID silicone fuel line (DUB 197 or similar)
- Cross head Phillips screw driver

4.1.2 Remove the stopper assembly from the tank and extract the clunk.

4.1.3 Using the 100 mm (4 in.) and the 50mm (2 in.) pieces of tubing and the stopper assembly, assemble the tubing, stopper assembly and clunk as shown below. Note that the 100mm piece of tubing is applied to straight end of one of the metal tubes.

4.1.4 Insert the clunk and tubing assembly into the fuel tank such as the external metal tubes are both pointing up and the tubing inside is oriented as shown in the cut-away depiction shown below.

4.1.5 Push the stopper firmly into the neck of the tank until the shoulder of the black stopper contacts the neck of the tank.

4.1.6 Ensure that the external metal tubes are pointing upwards as depicted here and then tighten the cinch bolt in the centre of the stopper until the external plastic disk begins to dimple inwards.

4.1.7 Attach a loose piece of tubing to each of the external metal tubes. Pinch one closed while blowing into the other. You should see the tank bulge slightly under pressure. Listen for air escaping while you continue to blow and keep the tank pressurized. If you hear any air leaking from around the stopper, back off the cinch bolt slightly, rotate the stopper slightly to and from and then retighten the cinch bolt slightly more securely. Test with air pressure again.

4.1.8 Hold the tank with the stopper end pointing upwards. Back light the tank assembly with a strong light from behind. You should see a ghost like image of the tubing and the clunk. Ensure the tubing has stayed oriented as per the cutaway depiction of step 4.1.4 and that the clunk swings freely to and fro when you move the tank from side to side. The clunk should be approximately 10mm from the end of the tank opposite the stopper.

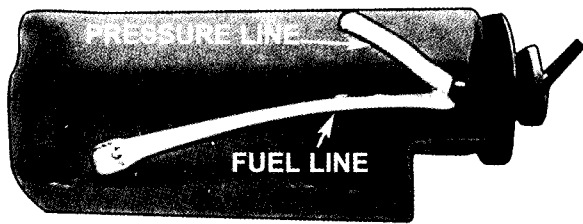

STEP 4.2 - INSTALLING THE FUEL TANK

This procedure should be done after the engine has been installing into the power module .

4.2.1 Before installing the fuel tank into your PILATUS please note that :

- One of the metal tube will supply fuel to the engine and allow you to fill the tank up. We call this the "fuel line".
- The other metal tube is connected to the muffler of your engine and serves to bring engine pressure into the tank to help force fuel out the fuel line into the engine. We call this line that is normally connected to your muffler the "pressure line" . It also serves as a fuel overflow vent when topping the tank up with fuel.

4.2.2 Install the fuel tank to the POWER MODULE. Put the neck of the fuel tank go through the hole in the center of the power module so that the "fuel line" and the "pressure line" visible on the other side of the power module. The fuel tank will sit on the two dowels (pre-installed by factory.)

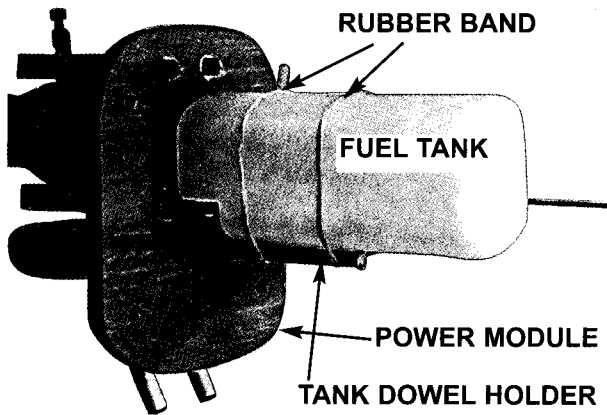

4.2.3 Use rubber band to ensure the fuel tank firmly into the two dowels.

4.2.4 When you are satisfied with the fit of the tank and the metal tubing, we suggest also trial fit your engine and ensure that the tank metal tubing clears the back engine with sufficient clearance

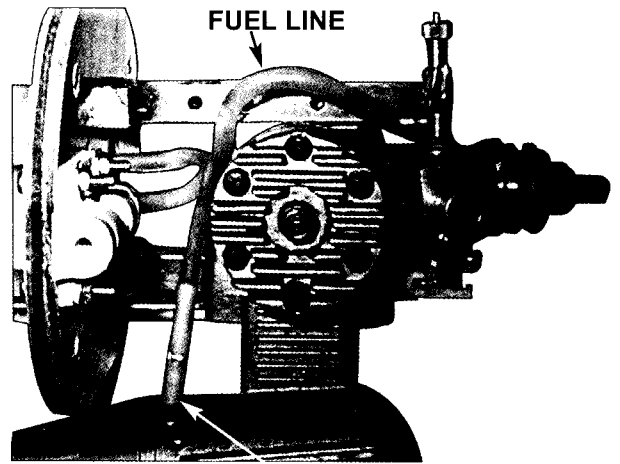

PHASE 5 - INSTALLING THE ENGINE

Engines vary quite a bit in sizes, styles, and brands but most have mounting lugs, a carburetor with a throttle (speed) control arm, a prop washer, a prop nut and a muffler. The procedure we describe here assumes that we are mounting a two stroke engine that has a side exhaust on the right (when viewed from the behind looking forward) and a throttle control arm on the left.

STEP 5.1 - MOUNTING THE ENGINE.

5.1.1 Engine thrust line is mark by factory it located on the POWER MODULE, Trial fit the POWER MODULE into the fuselage.

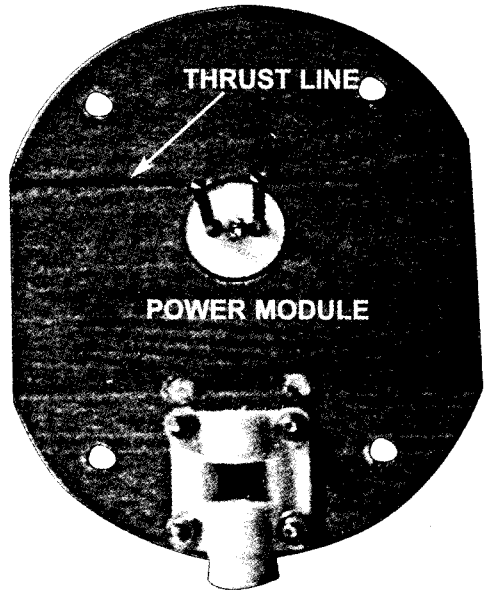

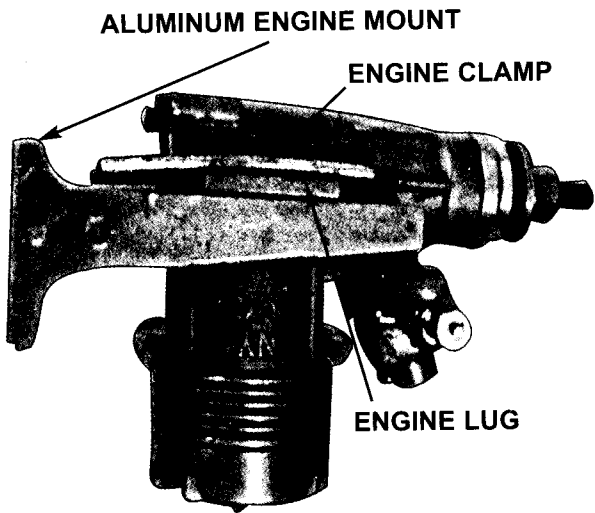

5.1.2 Clamp the engine to the engine mount, adjust the mount to make it levels on the mounting side by loosening the clamp on both sides of the T type engine mount. (We recommended inverted engine mount position as shown)

5.1.3 Put the engine, now with the engine mount on the power module align the thrust line with the engine sharp, decide the configuration of the mounting upright, 45,90,75 degree or inverted (in this book we show the inverted configuration)

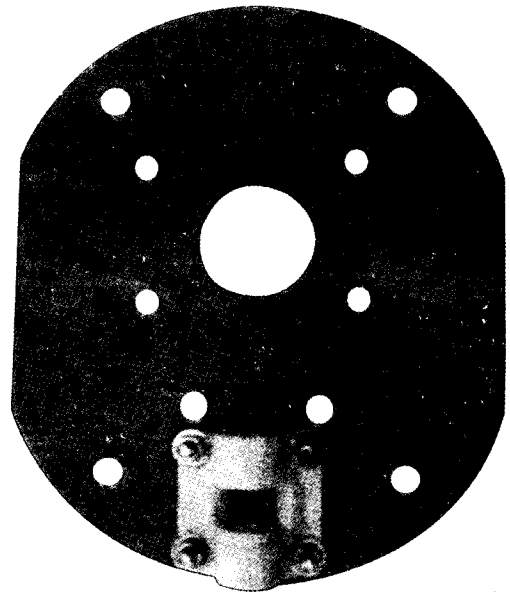

5.1.5 Mount the engine to the power module by using 4 black socket head machine screw (supplied) with metal washer

5.1.6 Drill a hole on the power module for the throttle push rod exit

5.1.7 Mount the power module to the fuselage by using four nuts and washer supplied. (Two nuts for right thrust have been installed by factory).

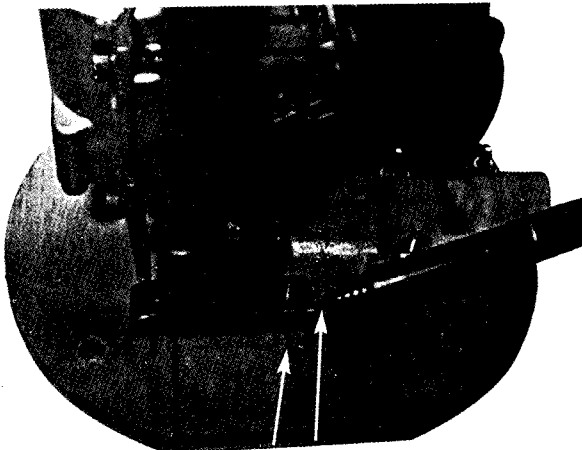

MARK FOR ENGINE MOUNT LOCATION

5.1.4 Use the pencil to mark the engine mount hole (as shown), once you have the hole location, drill the hole with 6mm (1/4 in) drill bit

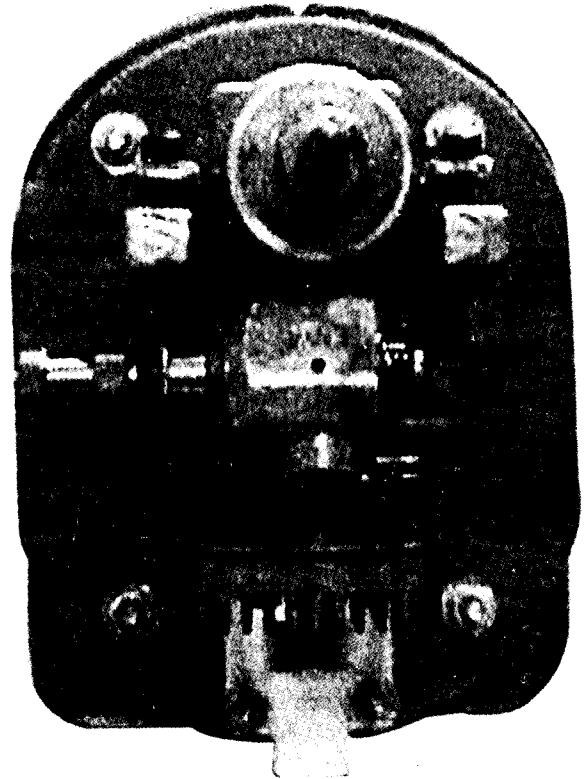

5.1.7 Install the muffler.

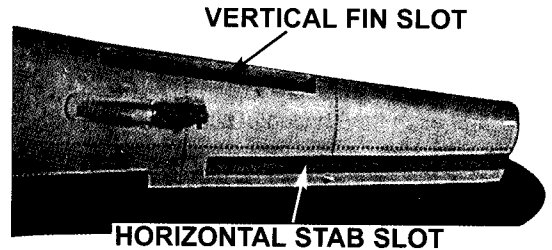
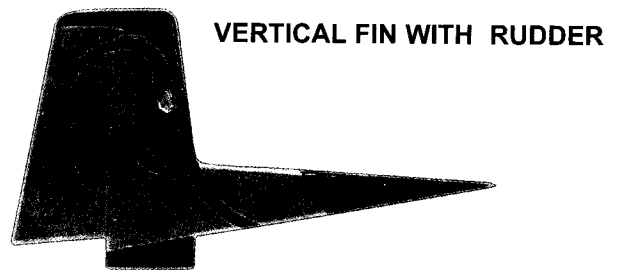
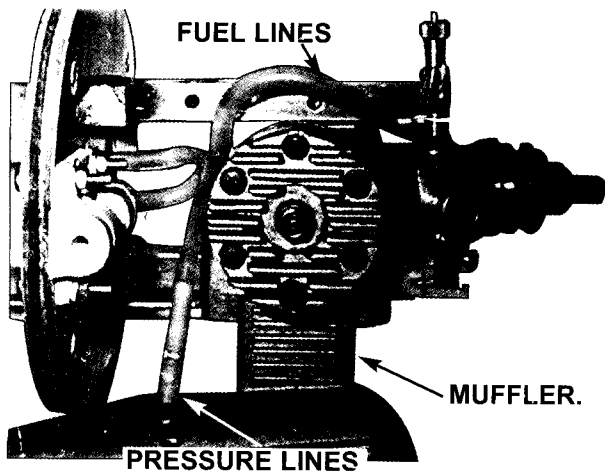

STEP 5.2 - CONNECTING THE FUEL & PRESSURE LINES

5.2.1 Connect fuel tubing from the tank fuel line to the carburetor .

5.2.2 Connect fuel tubing from the tank pressure line to the muffler

STEP 5.3 - INSTALLING THE SPINNER AND THE PROPELLER.

5.3.1 Consult your engine manual and select a suitable propeller.

5.3.2 Install the prop washer, the spinner backing plate, the propeller, the prop nut and the spinner cone. Ensure that they are all firmly affixed to the engine.

PHASE 6 - INSTALLING THE HORIZONTAL STABILIZER ASSEMBLY.

The horizontal stabilizer assembly is the smaller wing-like assembly that makes up the horizontal portions of the tail feathers on your model. The moveable control surfaces are called elevators and control the model's rate of rise or descent. The elevator are pre-hinged and permanently attached at the factory.

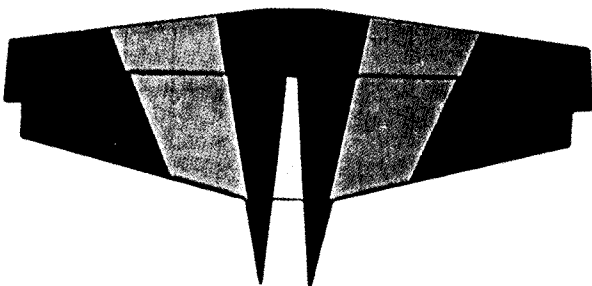

HORIZONTAL STAB WITH ELEVATOR

The stable, predictable and enjoyable nature of your model is dependent on a great degree on installing the horizontal stabilizer assembly as close to perfectly straight as possible. It is well worthwhile to take particular care when installing the horizontal stabilizer assembly.

To install the horizontal stabilizer assembly you will need the following items:

- Horizontal stabilizer assembly with pre-installed elevators
- 30 minute Epoxy
- Epoxy brush or stir sticks.
- Disposable mixing dish for the Epoxy
- Masking tape or pin to hold the horizontal stabilizer in position while the epoxy sets.
- Pencil
- Tape measure
- Paper towels.

STEP 6.1 - TRIAL FIT & MEASURE

6.1.1 Trial fit the horizontal stabilizer assembly by inserting it into the horizontal slot firmly and ensure that is completely inserted. The intent is to position the horizontal stabilizer assembly so that it is centered evenly left to right and mounted straight so that the distance from the left tip of the assembly to the center of the nose of the fuselage is the same distance as that measured from the right tip of the assembly to the nose of the fuselage.

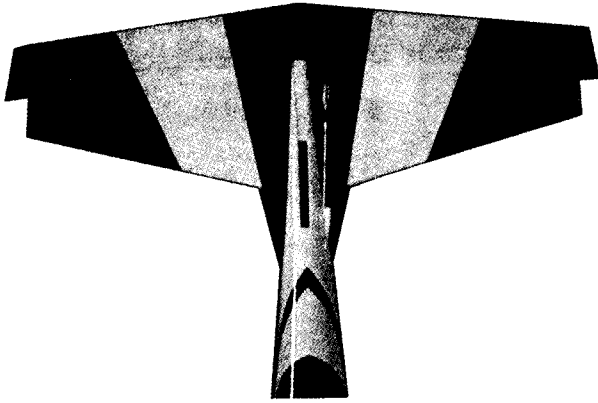

6.1.2 Use the tape measure to carefully measure the distances and align the horizontal stabilizer assembly.

6.1.3 Mark the alignment lines with a pencil or masking tape on the assembly exactly where the slot in the fuselage meets the horizontal stabilizer assembly. Mark all four intersections, left and right, top and bottom.

6.1.4 Remove the horizontal stabilizer assembly from the fuselage slot.

STEP 6.2 - PREPARE AND APPLY GLUE

6.2.1 Draw four more "removal" lines on the assembly, parallel to and 1/8" inside of the alignment lines.

6.2.2 Using a very light touch and a hobby knife, cut along the removal lines and peel away the covering to expose a wedge shaped swath of wood along the centerline of the horizontal stabilizer assembly. It is very important NOT to cut into the wood when removing the plastic covering. Use a very light touch. If you do cut into the wood, wick thin CA adhesive into the cut line.

REMOVAL COVERING AREA

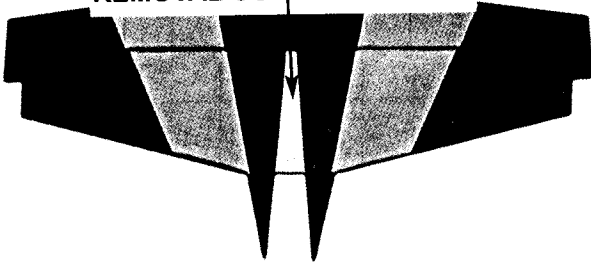

6.2.3 Mix approximately 1 ounce of 30-minute Epoxy. Do not use faster curing Epoxy. It does not have the strength of working time required. Do not skimp on the amount of 30-minute Epoxy. It is extremely important to use plenty of Epoxy when gluing the horizontal stabilizer assembly to the fuselage.

6.2.4 Using an Epoxy brush or stir stick, apply a liberal

coating of Epoxy to the exposed wooden area of the assembly and apply epoxy into the horizontal fuselage slot.

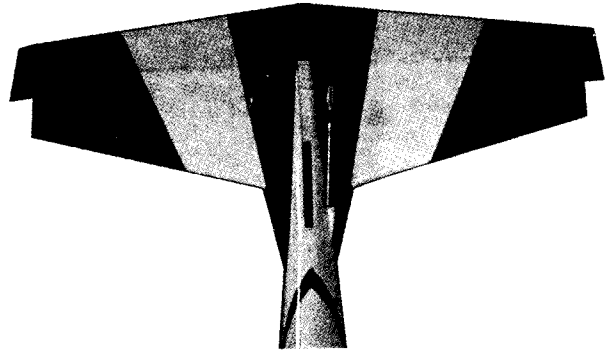

STEP 6.3 - FINAL INSTALLATION

6.3.1 Insert the horizontal stabilizer assembly into the horizontal fuselage slot keeping the assembly centered and aligned as you go.

6.3.2 Carefully push the assembly all the way into the slot. Push hard to ensure that it is all the way in. Wipe away any excess Epoxy with a paper towel. To avoid smearing Epoxy over the assembly or fuselage surface, wipe along the joint, not across them.

6.3.3 Carefully align the horizontal stabilizer assembly in accordance with the alignment marks you made earlier.

6.3.4 Use the tape measure to once again quickly check nose to tip distances and left to right centering for equivalencies.

6.3.5 Apply masking tape or pin to hold the horizontal stabilizer assembly in place while the Epoxy cures. Use the tape measure to make a final check and then set the fuselage aside and allow it to dry for at least two hours before handling. Let Epoxy cure overnight before flying.

PHASE 6 - INSTALLING THE VERTICAL STABILIZER ASSEMBLY.

The vertical fin assembly is the tail-like assembly that makes up the vertical portions of the tail feather on your model. The moveable control surface is called the rudder and controls the left and right directional movement of the model. The rudder is pre-hinged and permanently attached at the factory. To allow for steering control when on the ground the rudder movement is coupled to that of either the nose or tail wheel.

The stable, predictable and enjoyable nature of your model is dependent to a great degree on installing the vertical fin assembly as close to perfectly straight as possible. It is well worthwhile to take particular care when

installing the vertical fin assembly.

To install the vertical fin assembly you will need the following items:

- Vertical fin assembly with pre-installed rudder
- 30-minute Epoxy
- Epoxy brush or stir sticks
- Disposable mixing dish for the epoxy
- Masking tape or pin to hold the vertical fin assembly in position while the Epoxy sets.
- Pencil
- Tape measure
- Paper towels

STEP 7.1 - TRIAL FIT & MEASURE

7.1.1 Trial fit the vertical fin assembly by inserting it into the vertical slot that has been machined into the tail end of the fuselage. Push the assembly forward and down into the slot firmly and ensure that it is completely inserted both forward and down. The intent is to position the vertical fin assembly so that it is centered evenly left to right and mounted at right angles to the horizontal stabilizer so that the distance from the top tip of the assembly to the right tip of the horizontal stabilizer assembly is the same distance as that measured from the top tip to the left tip of the horizontal stabilizer assembly.

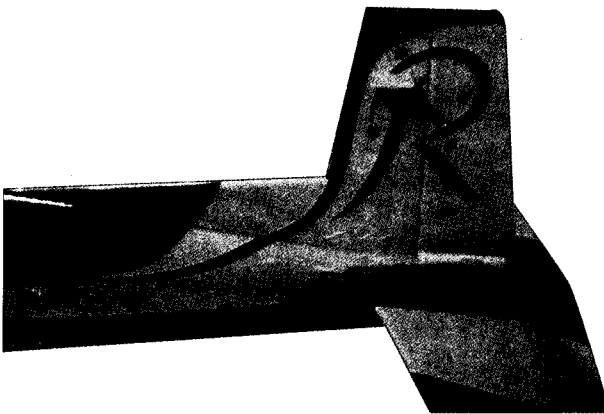

7.1.2 Use the tape measure the distances and align the vertical fin assembly.

7.1.3 Mark alignment lines with a pencil on the assembly exactly where the slot in the fuselage meets the vertical fin assembly. Mark both sides .left and right. Mark alignment lines on the fuselage top where the front portion of the vertical fin assembly meets the top of the fuselage.

7.1.4 Remove the vertical fin assembly from the fuselage slot.

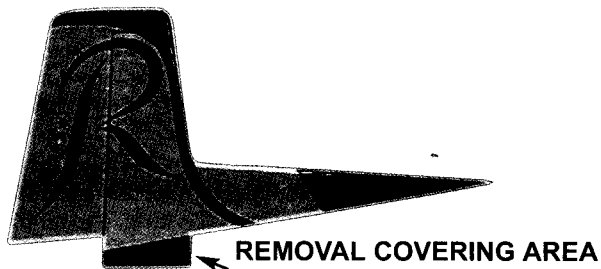

TEP 7.3 - FINAL INSTALLATION

7.3.1 Insert the vertical fin assembly into the vertical fuselage slot keeping the assembly centered and aligned as you go.

7.3.2 Carefully push the assembly all the way into the slot. Push hard forward and down to ensure that it is all the way in and down. To avoid smearing Epoxy over the assembly or the fuselage surface, wipe along the joints, not across them.

7.3.3 Carefully align the vertical fin assembly in accordance with the alignment marks you made earlier.

7.3.4 Use the tape measure to once again quickly check from the tip of the vertical fin assembly to the left and the right tips of the horizontal stabilizer assembly. Confirm that the vertical fin assembly is all the way forward and down in the fuselage slot.

7.3.5 Apply masking tape or pins to hold the vertical fin assembly in place while the Epoxy cures. Use the tape measure to make a final check and then set the fuselage aside and allow it to dry for at least two hours before handling. Let the epoxy cure over night before flying.

PHASE 8 - INSTALLING THE RADIO.

STEP 8.1. - INSTALLING THE SWITCH HARNESS AND THE RUDDER, ELEVATOR & THROTTLE SERVO'S

8.1.1 If you have not already done so, note carefully the orientation of the factory installed universal servo tray.

8.1.2 Remove the screws that were used in the factory to hold the servo tray in the fuselage. Retain the screws.

8.1.3 Carefully remove and retain the servo tray parts that were included in a bag with the tray.

8.1.4 Install the two black adjustment plates to the servo tray using three screws for the larger plate and two screws for the smaller plate. Tighten the screws but leave just enough slack to allow the adjustment plates to move to and fro.

THROTTLE CONTROL ROD

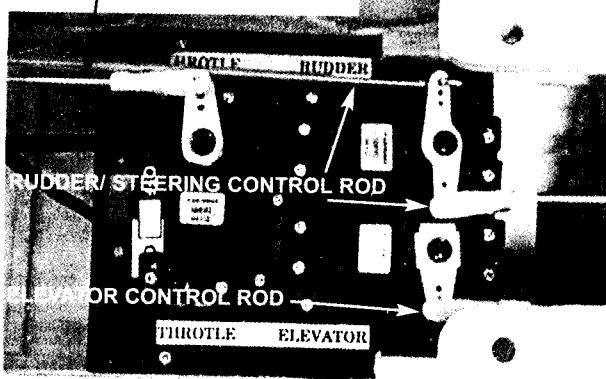

8.2.4 Adjust the length of the two piece throttle control rod using the two collars and the set screws. This two piece arrangement can accommodate a wide range of different engine throttles.

8.2.5 Snap the clevises firmly closed in a middle hole of the appropriate servo arm

8.2.6 Position and secure the floating wooden guide that holds the rudder and the elevator outer guide tubes. Attach the wooden guide to the nearby former at a level that keeps the rods level with the servo output arms.

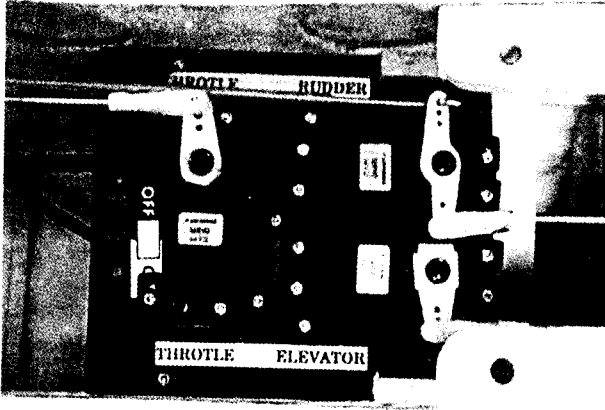

8.2.7 Attach an EZ connector to the servo arm opposite from the rudder. Center the nose wheel and cinch down the EZ connector to the nose gear steering control rod.

8.2.8 Position and limit the side to side and up or down movement of the nose gear steering control rod using one of the small wooden guide blocks provided. The guide block is made from wood and has a small groove inside. Tack it down with adhesive so that the metal rod moves freely in the groove. You may need two of these to guide the nose gear steering rod properly.

8.2.9 Remove the tape from the rudder and the elevator and free up the throttle control arm.

8.2.10 Turn on your transmitter and then your receiver. Confirm that the neutral positions are sustained.

8.2.11 Move the transmitter throttle, rudder and elevator sticks and ensure that the appropriate control surfaces move accordingly and in the correct directions.

- Pulling the transmitter elevator stick towards you should raise the elevator.

- Moving the transmitter rudder stick to the left should deflect the rudder to the left arm and turn the nose wheel to the left in a trike gear configuration.

- Moving the transmitter rudder stick to the right should deflect the rudder to the right and turn the nose wheel to the right in a trike gear configuration.

- Moving the transmitter throttle stick away from you should open the throttle wider.

- Moving the transmitter throttle stick towards you should reduce the opening in the throttle.

If any of these movements is reversed, consult your radio manual regarding servo reversing.

STEP 8.3 - ADJUST CONTROL SURFACE THROW LIMITS.

8.3.1 Adjust the deflection for the control surfaces to match the following guidelines

You can reduce the amount of throw by doing either or both of the following:

- From the servo end, move the clevis or EZ connector to a hole in the servo arm that is closer to the servo output shaft.

- From the control horn end, move the horn out further on the threaded shafts. Always confirm that the horn is still thoroughly engaged with the threaded shaft after you have adjusted it.

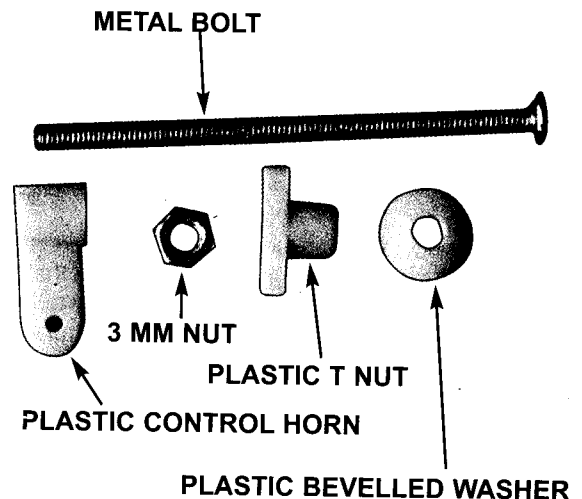

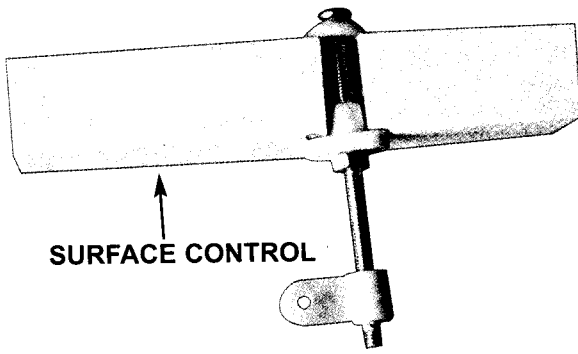

STEP 8.4 - INSTALLING THE RECEIVER BATTERY

8.4.1 Consult your radio manual for instructions about hooking up your receiver battery, receiver and switch harness.

8.4.2 We recommend locating the battery under the fuel tank

8.4.3 Wrap the battery pack securely in foam suitable for RC equipment and wrap the foam insulated pack in a plastic bag or cling wrap.

8.4.4 Thread the battery pack connector back through from beneath the fuel tank to the radio compartment by passing the battery connector through an opening beside the fuel tank.

8.4.5 Connect the battery connector to your radio system according to the radio manual.

STEP 8.5 - INSTALLING THE RECEIVER

8.5.1 Consult your radio manual for instructions about hooking up your receiver.

8.5.2 Plan where you are going to put the receiver with consideration for routing the antenna safely.

8.5.3 Wrap the receiver securely in foam suitable for RC equipment and wrap the foam insulated receiver in a plastic bag or cling wrap.

8.5.4 Generally in the absence of specific instructions from the radio manufacturer, it is recommended that the receiver should be placed where it is least likely to have impact during a crash. Keep the battery pack and other heavy loose items ahead of the receiver.

STEP 8.6 - CONFIRM RADIO OPERATION

8.6.1 Consult your radio manual for instructions about

testing and operating your radio system.

8.6.2 Pay particular attention to charging your radio system batteries and range testing the system before and after each flight.

8.6.3 Check that all controls are working correctly before and after each flight.

STEP 9.1 - BALANCING THE AIRCRAFT.

The CG for your PILATUS is located at 78 to 86 mm (3 to 3 1/2") back from the leading edge of the wing when the wing has been attached to the fuselage.

The CG is measured with the engine, radio gear and all other components installed but WITH NO FUEL IN THE TANK.

Set up the CG with the Mentor as it will be when you fly it BUT WITH NO FUEL IN THE TANK.

It is very important to have the CG correct. Flying your Mentor with the CG too far will likely lead to loss control and a crash.

If you discover that after you have assembled your Mentor and installed your radio and engine that the CG is incorrect you must bring the CG to the correct location by doing the following BEFORE FLYING :

- Move the battery pack fore or aft.
- Move other components fore or aft.
- Change engine to a lighter or heavier model.
- Add weight to the nose or tail. If adding it to the nose, try to make it useful by going to a heavier duty engine or adding a spinner with a heavy metal backing plate. As a last resort, add stick on "dead" weight where appropriate. For the initial flight, the CG should be located at 3" (78mm) back from the leading edge of the wing when the wing has been attached to the fuselage.

STEP 9.2 - CONFIRM MECHANICAL INTEGRITY

9.2.1 Once you have confirmed that the CG is correct, you should do a thorough review of the entire model before your first flight. Check everything twice! Every hook up, every coupling, everything! Do it twice!!

9.2.2 Before your first flight , have an experienced flyer review your work. Do not fly your Mentor until it has been checked out by a third party who knows how to fly and how to set up a model aircraft if this is your first symmetrical airplane.

9.2.3 Once you have completed your first flight, get in the habit of checking your PILATUS over before and after each flight! Don't fly if you find something that is not right!

CONTROL SURFACE THROWS RECOMMENDATION

NOTE : The throws are measured at the widest part of the elevator, rudder and aileron. Adjust the position of the pushrods at the control/servo horns to control the amount of throw. You may also use the ATV's if your transmitter has them but the mechanical linkages should still be set so that the ATV's are near 100% for best servo resolution.

	High rate	Low rate
ELEVATOR	3/4 " (18mm) up 3/4" (18mm) down	1/4" (7mm)up 1/4" (7mm)up
RUDDER	1" (25mm) right 1" (25mm) left	3/4" (18mm) right 3/4" (18mm) left
AILERON	1/2" (14mm) up 1/2"(14mm)down	1/2" (14mm)up 1/2" (14mm) down.

Note: If your radio does not have dual rates, then set the



control surfaces to move at the low rate throws.

**THIS UNIT MAKE YOUR MODEL LOOK MORE SCALE
AND MORE STABILITY AT ALL SPEED**